

Makro-Grip® 77, Étau 5 axes

Largeur des mors 77 mm, Plage de serrage 0 - 120 mm

Item No. 48120-77

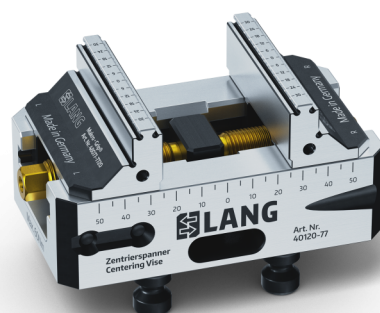

Plage de Serrage	0 - 120 mm
Dimensions	130 x 77 x 65 mm
Principe de Serrage	à engagement positif / par adhérence
Type de Composant	cubique
Conditionnement	1 Pièce
Poids	2.9 kg
Matériau	Acier

Makro-Grip® 77, Étau 5 axes

Largeur des mors 77 mm, Plage de serrage 0 - 120 mm

Item No. 48120-77

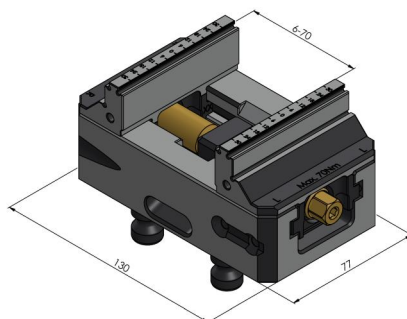
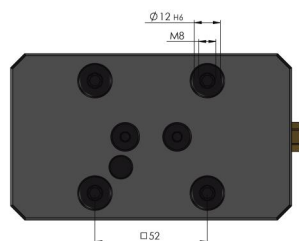

Makro-Grip® 77, Étau 5 axes

Largeur des mors 77 mm, Plage de serrage 0 - 120 mm



Item No. 48120-77

