

N° D'ART.	48160-77
DESCRIPTION	Makro-Grip® 77, Étau 5 axes, Largeur des mors 77 mm, Plage de serrage 0 - 160 mm
DATE DE PUBLICATION	04.05.2021

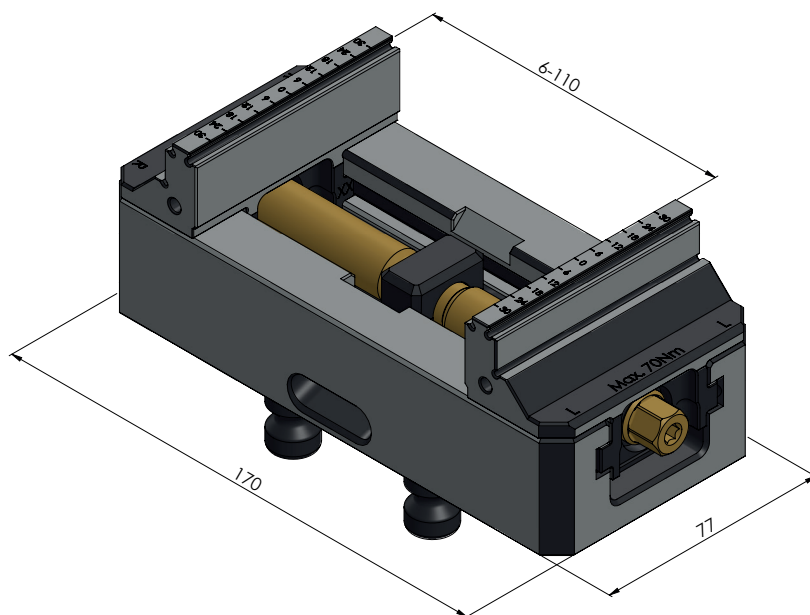

N° D'ART.	48160-77
DESCRIPTION	Makro-Grip® 77, Étau 5 axes, Largeur des mors 77 mm, Plage de serrage 0 - 160 mm
DATE DE PUBLICATION	04.05.2021

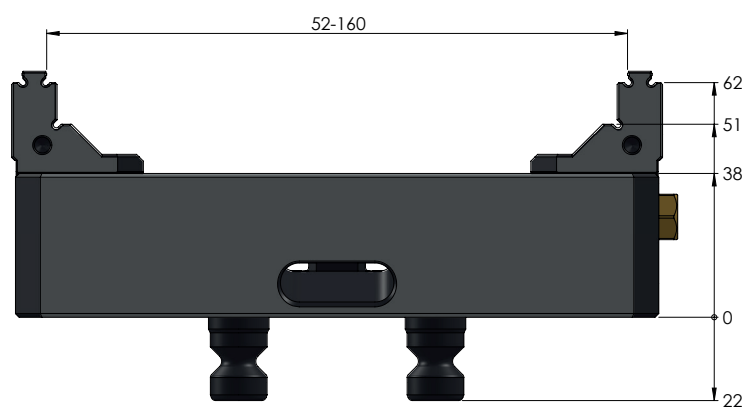

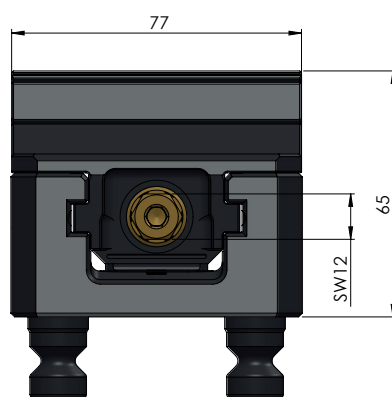

N° D'ART.	48160-77
DESCRIPTION	Makro-Grip® 77, Étau 5 axes, Largeur des mors 77 mm, Plage de serrage 0 - 160 mm
DATE DE PUBLICATION	04.05.2021