

Avanti 77, Profile Clamping Vice

jaw width 77 mm, max. clamping range 165 mm

Item No. 44160-77



Clamping range	0 - 165 mm (0" - 6.5")
Dimensions	170 x 77 x 51 mm (6.69" x 3.03" x 2.01")
Clamping method	by friction
Workpiece shape	prismatic / cylindrical / asymmetrical
Packaging Unit	1 Set
Weight	4.14 kg (9.13 lbs)
Material	Steel

Avanti 77, Profile Clamping Vice

jaw width 77 mm, max. clamping range 165 mm

Item No. 44160-77

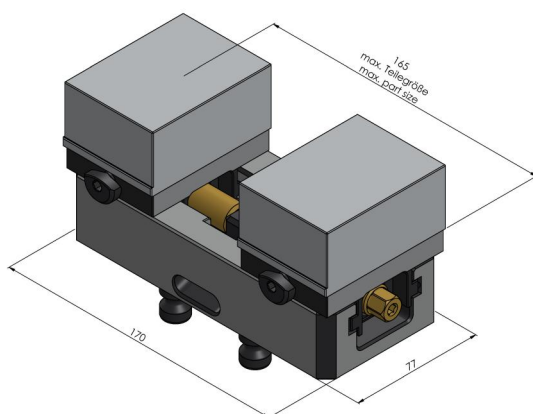
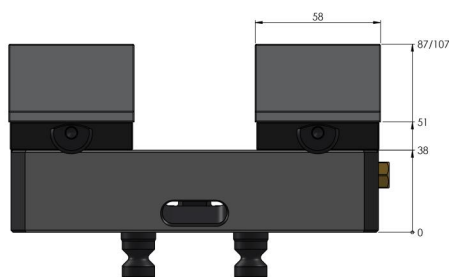

Avanti 77, Profile Clamping Vice

jaw width 77 mm, max. clamping range 165 mm

Item No. 44160-77

