

Avanti 125, Profile Clamping Vice

jaw width 125 mm, max. clamping range 205 mm

Item No. 44205-125



Clamping range	0 - 210 mm (0" - 8.27")
Dimensions	210 x 125 x 70 mm (8.27" x 4.92" x 2.76")
Clamping method	by friction
Workpiece shape	prismatic / cylindrical / asymmetrical
Packaging Unit	1 Set
Weight	11.1 kg (24.47 lbs)
Material	Steel

Avanti 125, Profile Clamping Vice

jaw width 125 mm, max. clamping range 205 mm

Item No. 44205-125

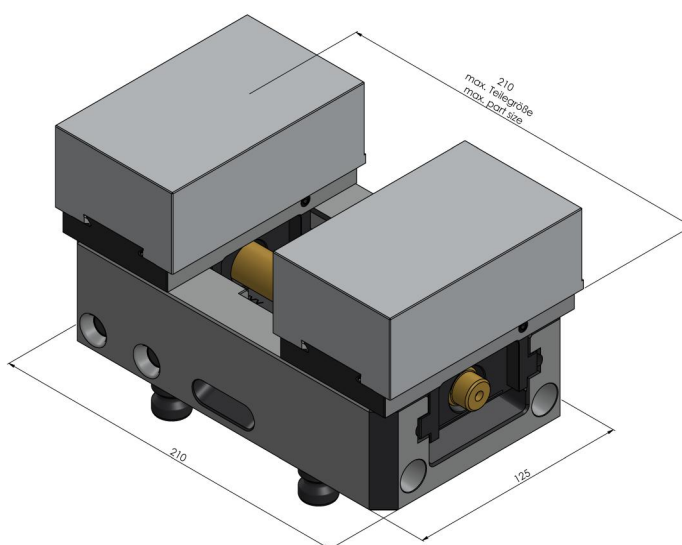
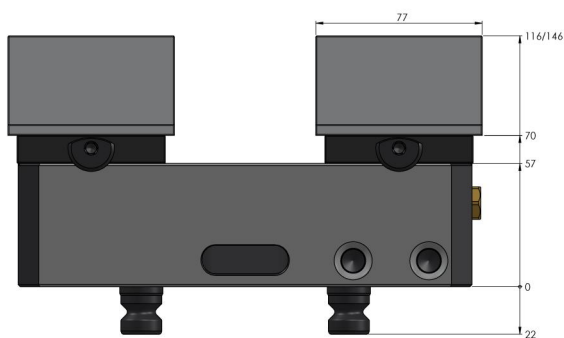

Avanti 125, Profile Clamping Vice

jaw width 125 mm, max. clamping range 205 mm

Item No. 44205-125

