

Vario-Tec 77, Zentrierspanner

Backenbreite 77 mm, max. Spannbereich 57 mm

Item No. 42057-77



Spannbereich	0 - 57 mm
Abmessungen	130 x 77 x 65 mm
Spannprinzip	kraftschlüssig
Bauteilform	kubisch
Verpackungseinheit	1 Stück
Gewicht	3.3 kg
Material	Stahl

Vario-Tec 77, Zentrierspanner

Backenbreite 77 mm, max. Spannereich 57 mm

Item No. 42057-77

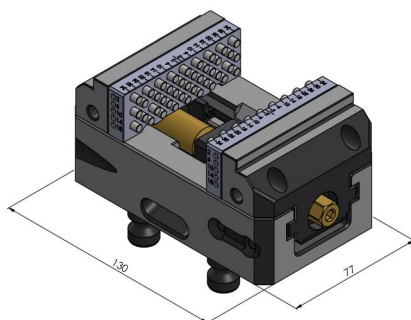
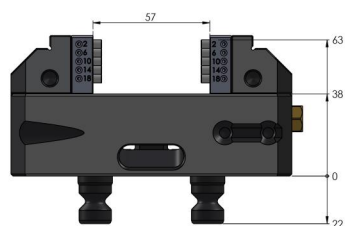

Vario-Tec 77, Zentrierspanner

Backenbreite 77 mm, max. Spannbereich 57 mm

Item No. 42057-77

