

Vario-Tec 77, Centering Vise

jaw width 77 mm, max. clamping range 57 mm

Item No. 42057-77



Clamping range	0 - 57 mm (0" - 2.24")
Dimensions	130 x 77 x 65 mm (5.12" x 3.03" x 2.56")
Clamping method	by friction
Workpiece shape	prismatic
Packaging Unit	1 Piece
Weight	3.3 kg (7.28 lbs)
Material	Steel

Vario-Tec 77, Centering Vise

jaw width 77 mm, max. clamping range 57 mm

Item No. 42057-77

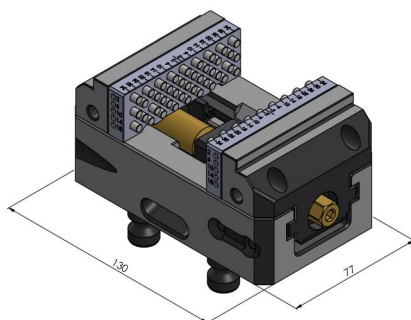
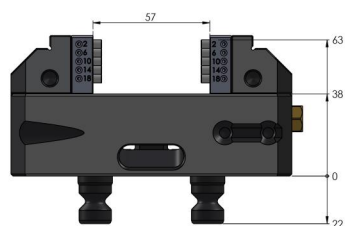

Vario-Tec 77, Centering Vise

jaw width 77 mm, max. clamping range 57 mm

Item No. 42057-77

