

Vario-Tec 77, Étau de centrage

Largeur des mors 77 mm, plage de serrage max. 57 mm



Item No. 42057-77



Plage de Serrage	0 - 57 mm
Dimensions	130 x 77 x 65 mm
Principe de Serrage	par adhérence
Type de Composant	cubique
Conditionnement	1 Pièce
Poids	3.3 kg
Matériau	Acier

Vario-Tec 77, Étau de centrage

Largeur des mors 77 mm, plage de serrage max. 57 mm

Item No. 42057-77

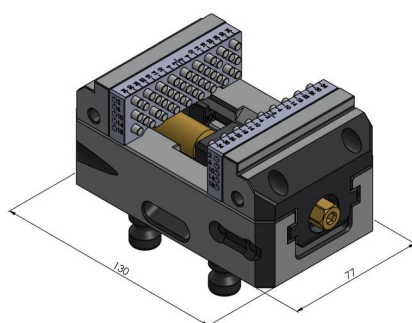
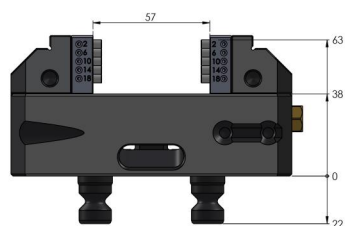

Vario·Tec 77, Étau de centrage

Largeur des mors 77 mm, plage de serrage max. 57 mm

Item No. 42057-77

