

Vario-Tec 125, Étau de centrage

largeur des mors 125 mm, plage de serrage max. 100 mm

Item No. 42102-125

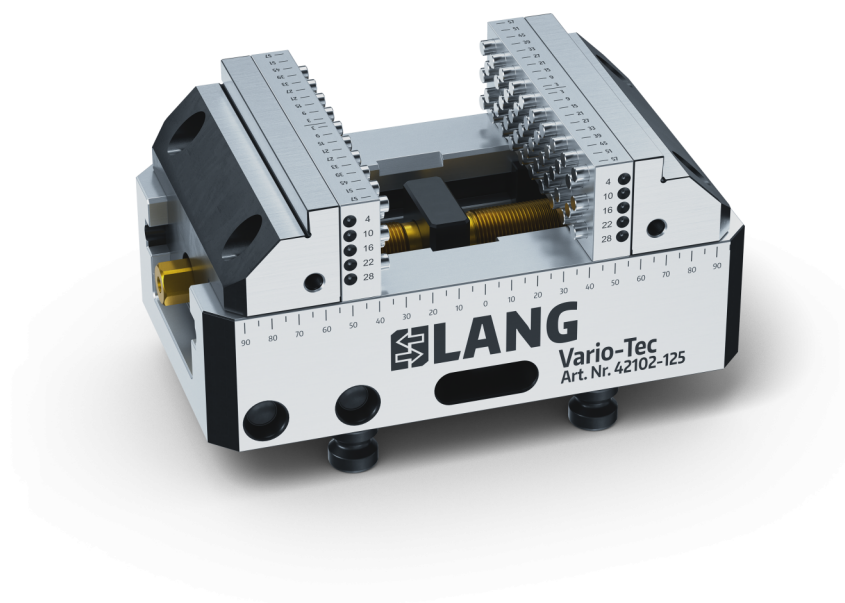

Plage de Serrage	0 - 100 mm
Dimensions	210 x 125 x 97 mm
Principe de Serrage	par adhérence
Type de Composant	cubique
Conditionnement	1 Pièce
Poids	12.1 kg
Matériau	Acier

Vario-Tec 125, Étau de centrage

largeur des mors 125 mm, plage de serrage max. 100 mm

Item No. 42102-125

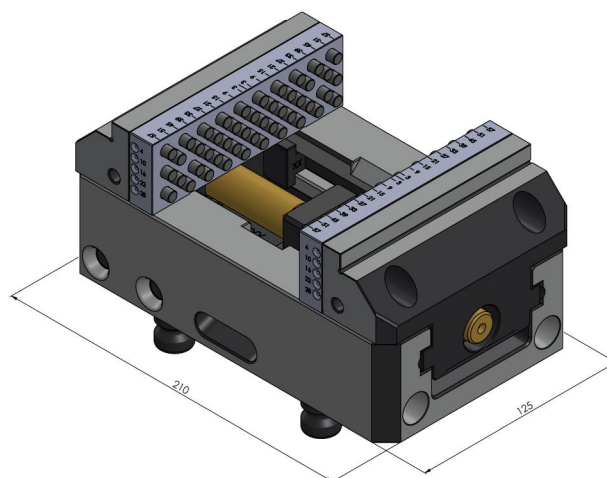
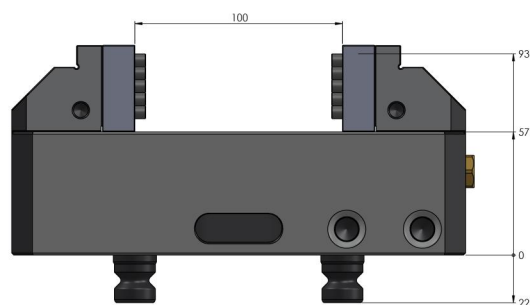

Vario-Tec 125, Étau de centrage

largeur des mors 125 mm, plage de serrage max. 100 mm

Item No. 42102-125

