

Quick-Point® 52, lapide a 4 facce

192 x 192 x 260 mm

Item No. 70264

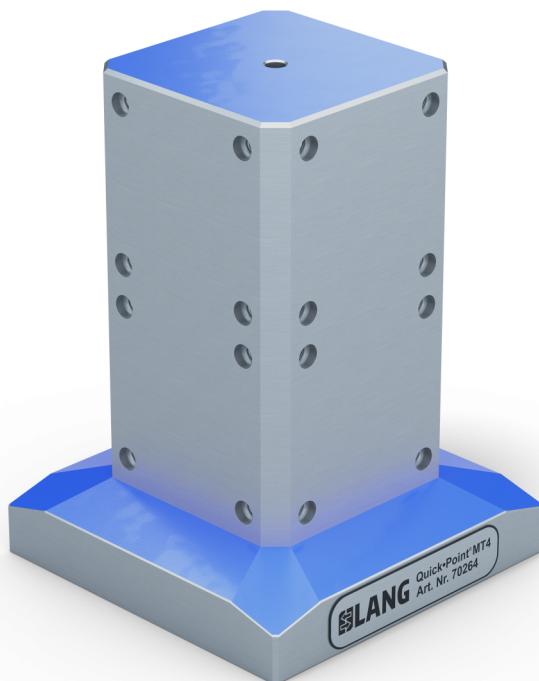

Dimensioni corpo	125 x 125 mm
Dimensioni piede	192 x 192 mm
Altezza totale	260 mm
Piastre a griglia numerica	8 x 75600 / 4 x 45621
Tipo di macchina	VMC / HMC
Unità di imballaggio	1 Pezzo
Peso	37.1 kg
Materiale	Acciaio

Quick-Point® 52, lapide a 4 facce

192 x 192 x 260 mm

Item No. 70264

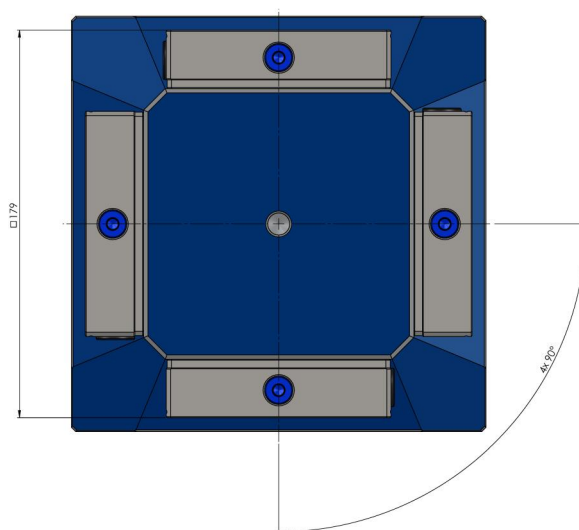
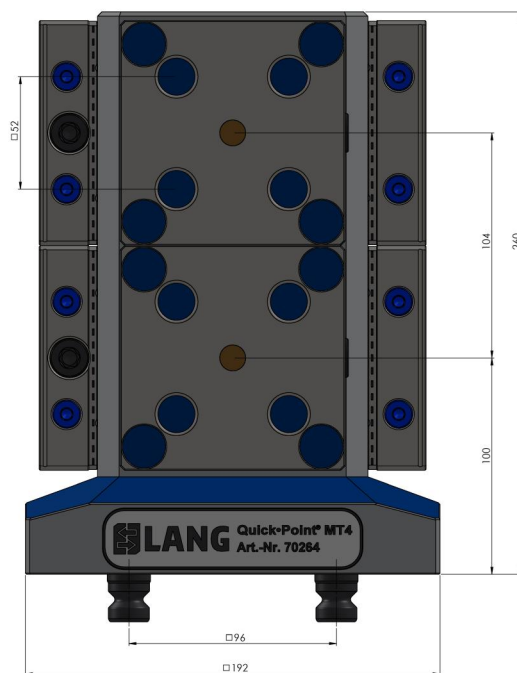

Quick-Point® 52, lapide a 4 facce

192 x 192 x 260 mm

Item No. 70264

